

ARCHANGEL 5 415 WIDE CHANDELIER

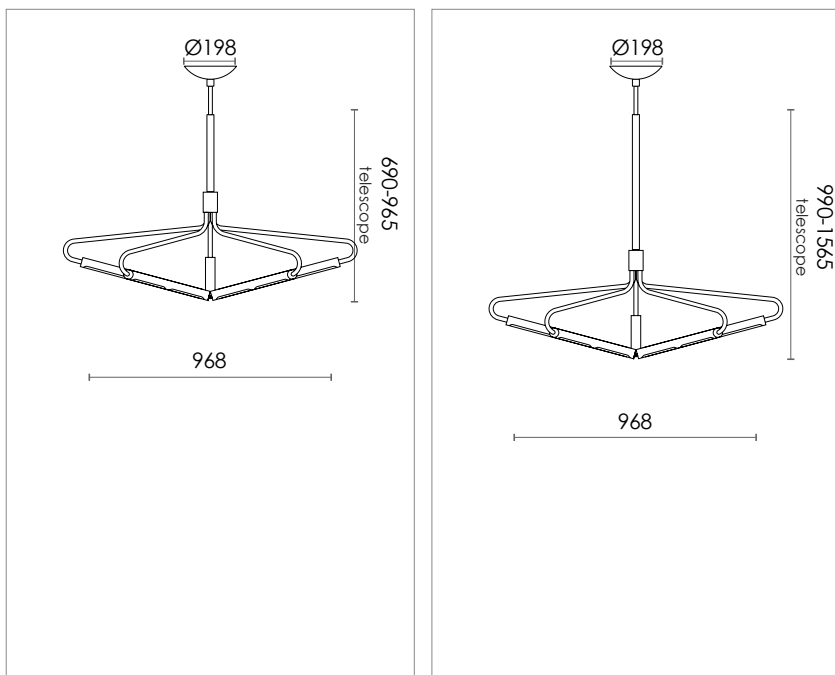



DESIGN SPECIFICATIONS

DIMENSIONS (mm)	W 968 x H 690-965 W 968 x H 990-1565
WEIGHT (kg)	8.6kg / 9.6kg
MATERIALS	THE LAMP IS MADE FROM CLEAR LACQURED BRASS OR POWDER COATED STEEL.
CORD (mm)	NO
ENVIRONMENT	INDOOR
DESIGN BY	NICLAS HOFLIN
DESIGN YEAR	2023

ELECTRICAL SPECIFICATIONS

SWITCH	NO
LIGHT SOURCE	INTEGRATED LED 29 W - 2700 K
DIMMABLE	YES
MAX (W)	29 W
VOLTAGE	230 / 240
CLASS	2
IP	20

COLOURS

	BLACK H 690-965 ART.NO. 816104005	H 990-1565 ART.NO. 816105005
	BRASS H 690-965 ART.NO. 816104001	H 990-1565 ART.NO. 816105001