

ANGEL 5 500 WIDE CHANDELIER

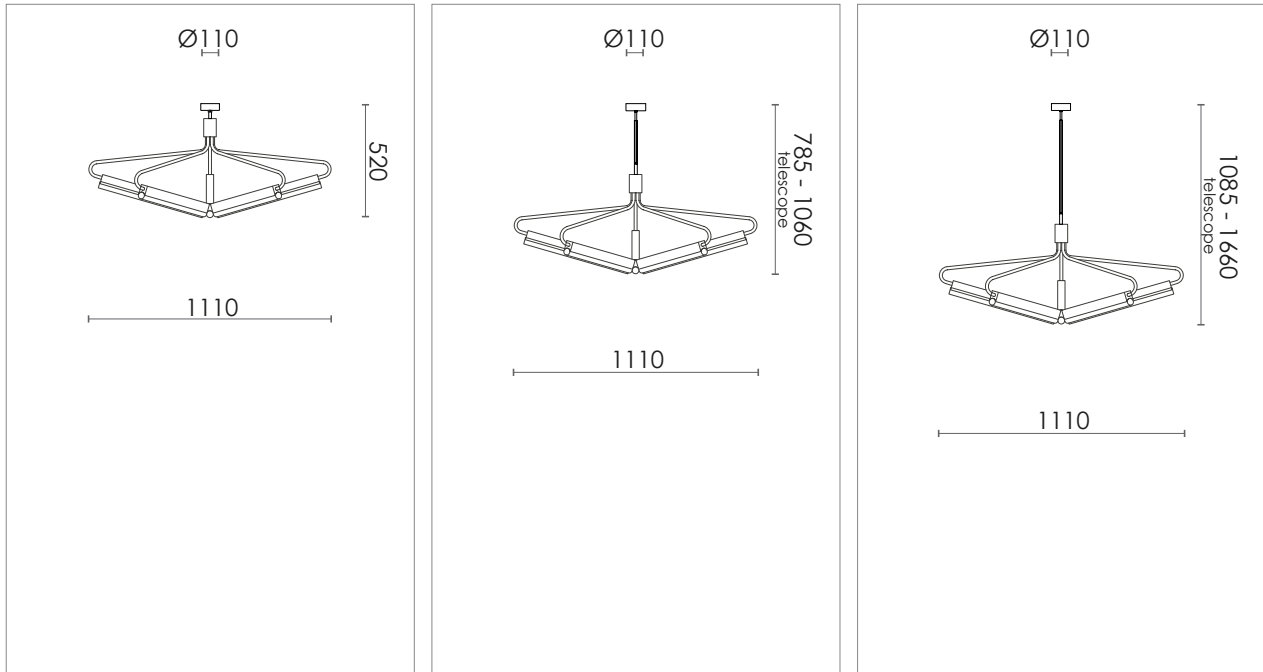

DESIGN SPECIFICATIONS

DIMENSIONS (mm)	W 1110 x H 520 W 1110 x H 785-1060 W 1110 x H 1084-1660
WEIGHT (kg)	- / - / -
MATERIALS	THE LAMP IS MADE FROM CLEAR LACQURED BRASS, STEEL OR POWDER COATED STEEL.
CORD (mm)	NO
ENVIRONMENT	INDOOR
DESIGN BY	NICLAS HOFLIN
DESIGN YEAR	2019

ELECTRICAL SPECIFICATIONS

SWITCH	NO
BULB HOLDER	S14S
LIGHT SOURCE	INCLUDED 5 X 7 W DIMMABLE LED - 2700 K
DIMMABLE	YES
MAX (W)	35 W LED
VOLTAGE	230 / 240
CLASS	1
IP	20

COLOURS

	BLACK H 640 ART.NO. 916151005	H 905-1180 ART.NO. 916152005	H 1205-1780 ART.NO. 916153005
	BRASS H 640 ART.NO. 916151001	H 905-1180 ART.NO. 916152001	H 1205-1780 ART.NO. 916153001
	BRONZE-COLOR H 640 ART.NO. 916151223	H 905-1180 ART.NO. 916152223	H 1205-1780 ART.NO. 916153223
	STEEL H 640 ART.NO. 916151500	H 905-1180 ART.NO. 916152500	H 1205-1780 ART.NO. 916153500